

“MINERVA CONSTRUCTION GROUP”

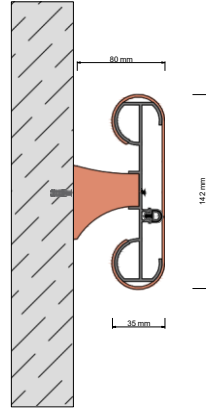

Your vision our future



- 142 mm genişlik.
 - Duvardan 80 mm derinlik.
 - Alt konstrüksiyon sürekli alüminyum.
 - Alüminyum profil üzerinde darbe emici kauçuk fitiller mevcuttur.
 - Üst kapak vinil akrilik malzeme. (Çizilmez, antibakteriyel, yangın yürütmez özellikte.)
 - Profil boyları 4 metre.
 - Duvara 50-70 cm aralarla vinil akrilik malzemeden olan kendi duvar bağlantı elemanı (tutamak elemanı) ile adapte edilir.
 - Tutunma imkanı sağlayan yapısıyla hem hastanın destek almasını hem duvarın korunmasını sağlar.
 - Tutamak elemanları duvar yapısına göre duvara değişik vida ve dübellerle monte edilir.
- 142 mm width.
 - 80 mm witch from wall.
 - Lower construction continuously aluminum profile.
 - Impact-absorbing rubber gaskets are available on aluminium profile.
 - The top cover is vinyl acylic materiati (Scratch-proof, antibacterial, fireproof features).
 - Profile lengths are 4 meters.
 - The wall fitting apart (the handle unit), which is vinyl acrylic material, are adapted with 50-70 cm intervals.
 - The holding feature provide opportunity of protect wall and patients get support.
 - Handfold components should mount with proper wall plug and screw.

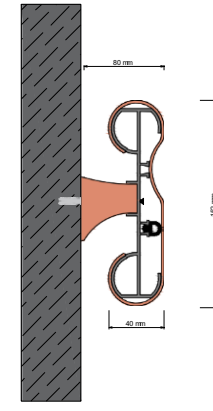
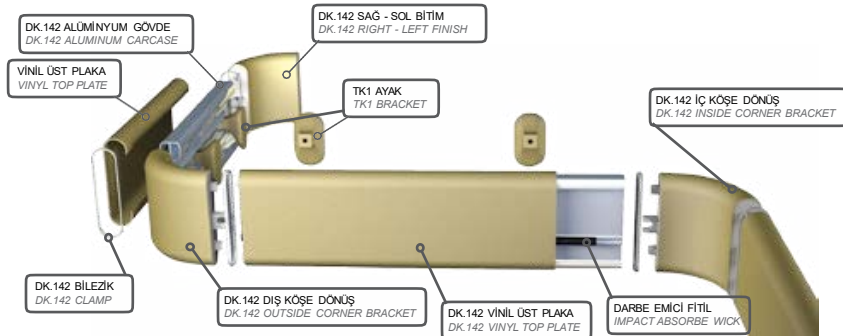

- 152 mm genişlik.
 - Duvardan 80 mm derinlik.
 - Alt konstrüksiyon sürekli alüminyum.
 - Alüminyum profil üzerinde darbe emici kauçuk fitiller mevcuttur.
 - Üst kapak vinil akrilik malzeme. (Çizilmez, antibakteriyel, yangın yürütmez özellikte.)
 - Profil boyları 4 metre.
 - Duvara 50-70 cm aralarla vinil akrilik malzemeden olan kendi duvar bağlantı elemanı (tutamak elemanı) ile adapte edilir.
 - Tutunma imkanı sağlayan yapısıyla hem hastanın destek almasını hem duvarın korunmasını sağlar.
 - Tutamak elemanları duvar yapısına göre duvara değişik vida ve dübellerle monte edilir.
- 152 mm width.
 - 80 mm witch from wall.
 - Lower construction continuously aluminum profile.
 - Impact-absorbing rubber gaskets are available on aluminium profile.
 - The top cover is vinyl acrylic material. (Scratch-proof, antibacterial, fireproof features).
 - Profile lengths are 4 meters.
 - The wall fitting apart (the handle unit), which is vinyl acrylic material, are adapted with 50-70 cm intervals.
 - The holding feature provide opportunity of protect wall and patients get support.
 - Handfold components should mount with proper wall plug and screw.

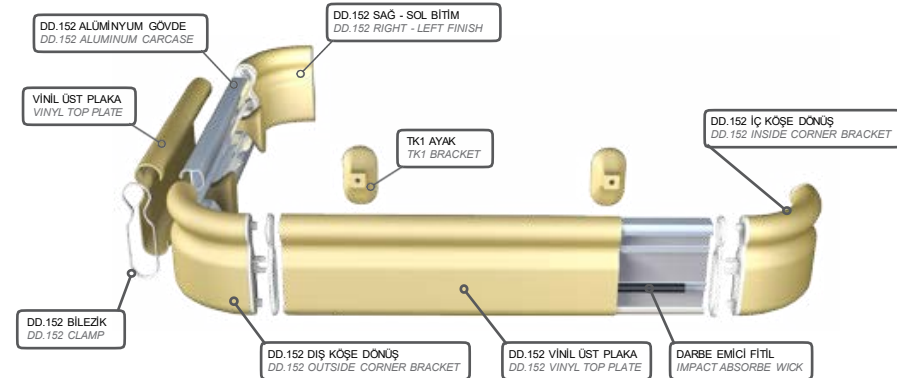

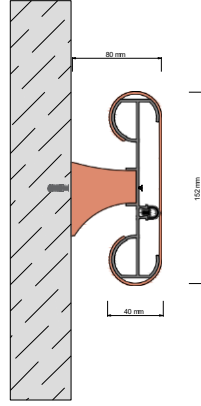

- 152 mm genişlik.
- Duvardan 80 mm derinlik.
- Alt konstrüksiyon sürekli alüminyum.
- Alüminyum profil üzerinde darbe emici kauçuk fitiller mevcuttur.
- Üst kapak vinil akrilik malzeme. (Çizilmez, antibakteriyel, yangın yürütmez özellikte.)
- Profil boyları 4 metre.
- Duvara 50-70 cm aralarla vinil akrilik malzemeden olan kendi duvar bağlantı elemanı (tutamak elemanı) ile adapte edilir.
- Tutunma imkanı sağlayan yapısıyla hem hastanın destek almasını hem duvarın korunmasını sağlar.
- Tutamak elemanları duvar yapısına göre duvara değişik vida ve dübellerle monte edilir.

- 152 mm width.
- 80 mm witch from wall.
- Lower construction continuously aluminum profile.
- Impact-absorbing rubber gaskets are available on aluminium profile.
- The top cover is vinyl acyfic material. (Scratch-proof, antibacterial, fireproof features).
- Profile /engths are 4 meters.
- The wall fitting apart (the handle unit), which is vinyl acyfic material, are adapted with 50-70 cm intervals.
- -The holding feature provide opportunity of protect wall and patients get support.
- Handfold components should mount with proper wall plug and screw.

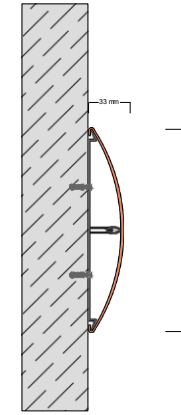
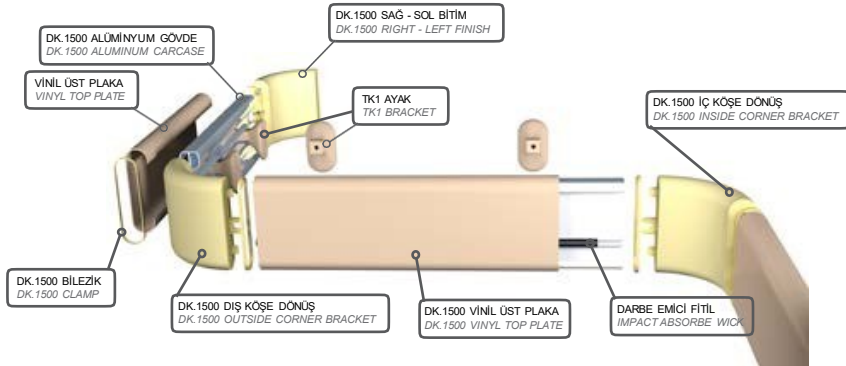

- 200 mm genişlik
- Duvardan 33 mm derinlik.
- Alt konstrüksiyon sürekli alüminyum profili.
- Üst kapak vinil akrilik malzeme. (Çizilmez, antibakteriyel, yangın yürütmez özellikte.)
- Profil boyları 4 metre.
- Duvar yapısına uygun dübel ve vida ile monte edilir.

- 200 mm width.
- 33 mm depth from wall.
- Lower construction continuously aluminum profile.
- The top cover is vinyl acyfic material (scratch-proof, antibacterial, fireproof features).
- Profile height 4 meter.
- Handfold components should mount with proper wall plug and screw.



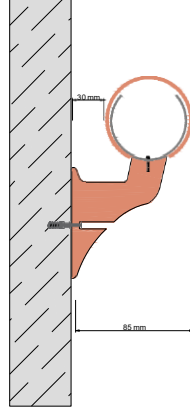

- Boru çapı 50 mm genişlik.
- Duvardan 85 mm derinlik.
- Alt konstrüksiyon sürekli alüminyum profilli.
- Üst kapak vinil akrilik malzeme. (Çizilmez, antibakteriyel, yangın yürütmez özellikte.)
- Profil boyları 4 metre.
- Merdiven boşluklarında veya koridorlarda tutunmayı sağlamak amacı ile kullanılır.
- 50-75 cm aralıklarla duvarın yapısına uygun vidalarla duvara vidalanır.

- Pipe diameter 50 mm width.
- 85 mm width from wall.
- Lower construction continuously aluminum profile.
- The top cover is vinyl acrylic material (scratch-proof, antibacterial, fireproof features).
- Intended use is to hold in stairwell and corridor.
- It is adapted with screws 50-75 cm intervals according to wall structure.

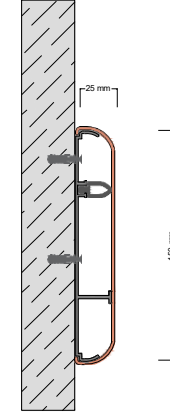
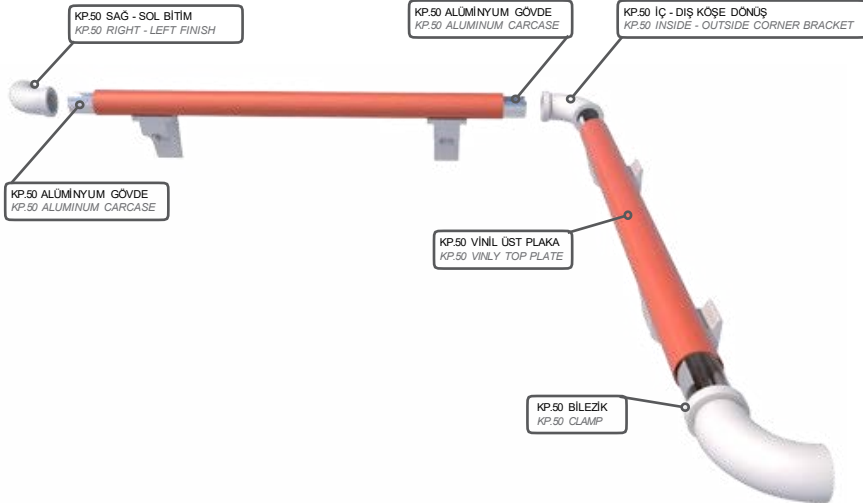

- 150 mm genişlik.
- Duvardan 25 mm derinlik.
- Alt konstrüksiyon sürekli alüminyum profilli.
- Alüminyum profil üzerinde darbe emici kauçuk fitiller mevcuttur.
- Üst kapak vinil akrilik malzeme. (Çizilmez, antibakteriyel, yangın yürütmez özellikte.)
- Profil boyları 4 metre.
- Duvara 50-75 cm aralıklarla duvarın yapısına uygun vidalar ile duvara adapte edilir.

- 150 mm width.
- 25 mm width from wall.
- Lower construction continuously aluminum profile.
- Impact-absorbing rubber gaskets are available on aluminium profile.
- The top cover is vinyl acrylic material. (Scratch-proof, antibacterial, fireproof features).
- Pratik> lengths are 4 meters.
- It is adapted with screws 50-75 cm intervals according to wall structure.

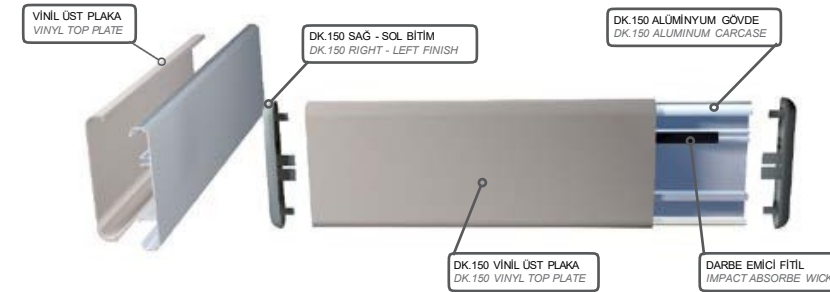

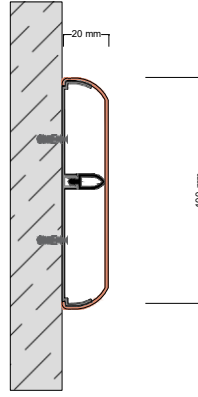

- 100 mm genişlik.
- Duvardan 20 mm derinlik.
- Alt konstrüksiyon sürekli alüminyum profili.
- Alüminyum profil üzerinde darbe emici kauçuk fitiller mevcuttur.
- Üst kapak vinil akrilik malzeme. (Çizilmez, antibakteriyel, yangın yürütmez özellikte.)
- Profil boyları 4 metre.
- Duvara 50-75 cm aralarla duvarın yapısına uygun vidalar ile duvara adapte edilir.
- 100 mm width.
- 20 mm witch from wall.
- Lower construction continuously aluminum profile.
- Impact-absorbing rubber gaskets are available on aluminium profile.
- The top cover is vinyl acrylic materiat (Scratch-proof, antibacterial, fireproof features). - Profile lengths are 4 meters.
- It is ataped with screws 50-75 cm intervals according to wall structure.

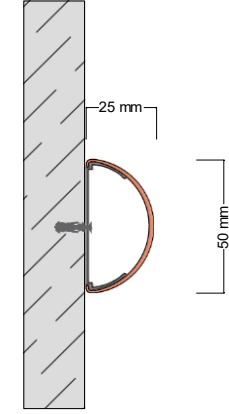
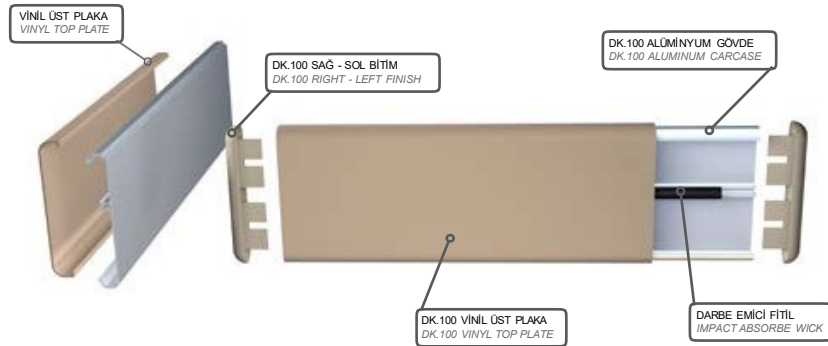

- 50 mm genişlik.
- Duvardan 25 mm derinlik.
- Alt konstrüksiyon sürekli alüminyum profili.
- Üst kapak vinil akrilik malzeme. (Çizilmez, antibakteriyel, yangın yürütmez özellikte.)
- Profil boyları 4 metre.
- 50-75 cm aralıklarla duvarın yapısına uygun vidalarla duvara vidalanır.
- Sandalye ve bekleme koltuklartnin arkasında duvar zarar görmemesi için kullanılır.
- 50 mm width.
- 25 mm witch from wall.
- Lower construction continuously aluminum profile.
- The top cover is vinyl acrylic material. (Scratch-proof, antibacterial, fireproof features).
- Profile lengths are 4 meters.
- It is adapted with screws 50-75 cm inter-vals according to wall structure.
- Intended used is to protect wall behind the seats and waiting armchairs.

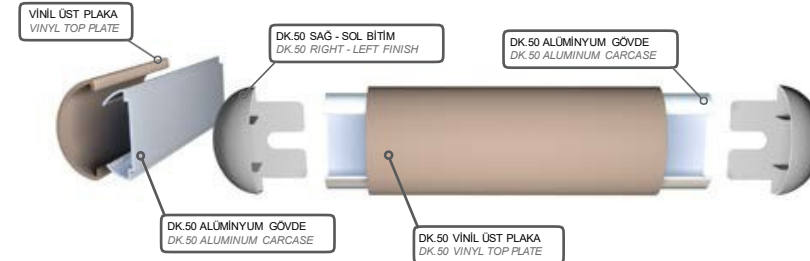

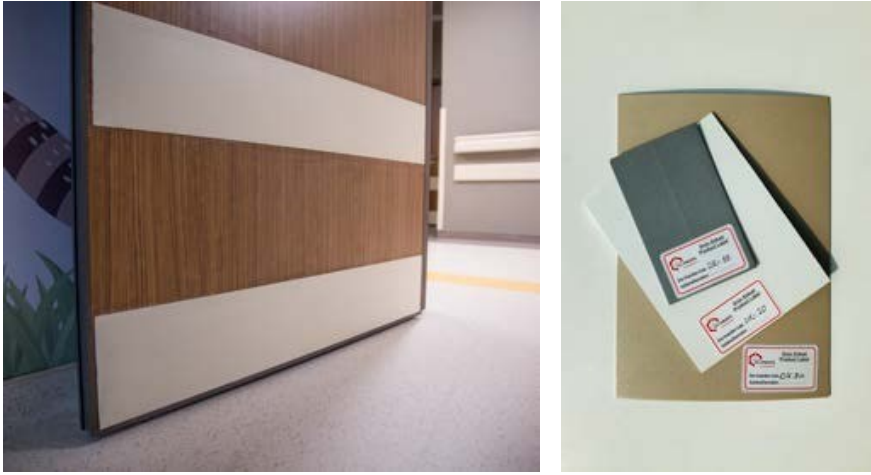

- 100, 200 ve 300 mm genişliğinde.
- 2 mm kalınlıkta olup, duvara yapıştırıcı ile uygulanır.
- Vinil akrilik malzeme. (Çizilmez, antibak-teriyel, yangın yürütmez özellikte.)
- Profil boyları 4 metre.

- 100, 200 and 300 mm width.
- Has 2 mm thickness and used with glue to the wall.
- The top cover is vinyl acrylic material (scratch-proof, antibacterial, fireproof features).
- Profile lengths are 4 meters.

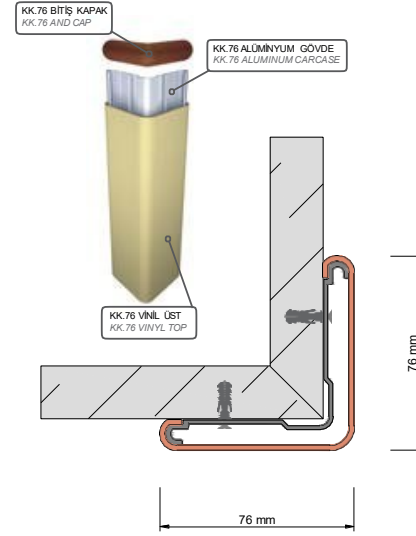
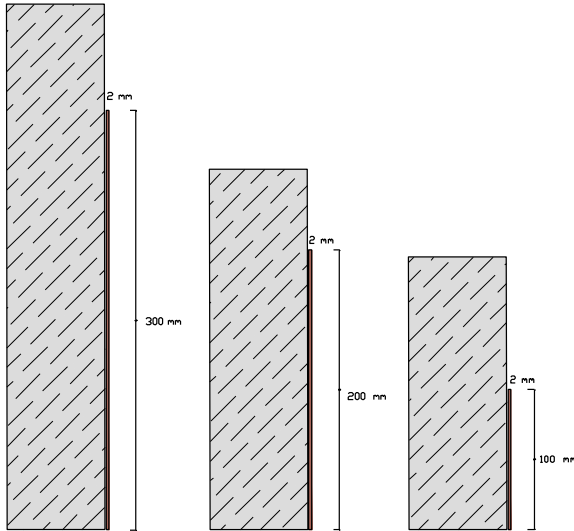
**KK.76**

- Köşe koruma profilleri 76x76 mm genişlikte 90 derecelik dönüğe uygundur.
- Kolan ve duvar köşelerini koruma fonksiyonlarını yerine getirebilecek uygun bir boyda dikey olarak uygulanır.
- Profil bitimlerinde bitim kapağı vardır.
- Doğrudan köşeye yapıştırılan veya alüminyum takviye profiline geçirilerek gizli vida ile tespit edilen iki tipi mevcuttur.
- Köşe koruma profilleri, hastanelerde sedye ve tekerlekli sandalyelerin, havaalanları, otel ve alışveriş merkezlerinde de servis ve el arabalarının çarpmalarına karşı sütun ve duvar köşelerini korumak amacıyla kullanılır.

- Corner protection profiles 76x76 mm. Wide and proper for 90 degree turp.
- Appliance aimed to protect column and wall comers and used with proper height vertically.
- There is a profile tap at the profile ending.
- There are two types which directly appose to the corner or attached with hidden screw to aluminium assistance profile.
- Corner protection profiles used for to protect comers and walls againts to litters and wheelchair where at the hospital, airport, hotel and shopping centers.

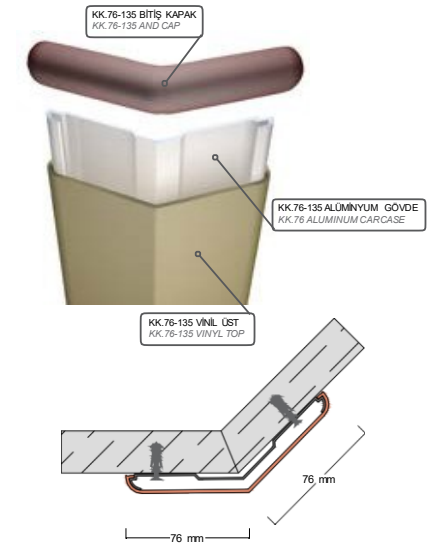
**KK.76-135**

- Köşe koruma profilleri 76x76 mm genişlikte 135 derecelik dönüğe uygundur.
- Kolon ve duvar köşelerini koruma fonksiyonlarını yerine getirebilecek uygun bir boyda dikey olarak uygulanır.
- Profil bitimlerinde bitim kapağı vardır.
- Doğrudan köşeye yapıştırılan veya alüminyum takviye profiline geçirilerek gizli vida ile tespit edilen iki tipi mevcuttur.
- Köşe koruma profilleri, hastanelerde sedye ve tekerlekli sandalyelerin, havaalanları, otel ve alışveriş merkezlerinde de servis ve el arabalarının çarpmalarına karşı sütun ve duvar köşelerini korumak amacıyla kullanılır.

- Corner protection profiles 76x76 mm. Wide and proper for 135 degree tum.
- Appliance aimed to protect column and wall comers and used with proper height vertically.
- There is a profile tap at the profile ending.
- There are two types which directly appose to the corner or attached with hidden screw to aluminium assistance profile.
- Corner protection profiles used for to protect comers and walls againts to litters and wheelchair where at the hospital, airport, hotel and shopping centers.

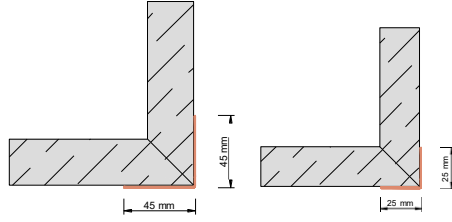
**KK.44**

- Köşe koruma profilleri, hastanelerde sedye ve tekerlekli köşe koruma profilleri 45x45 mm genişlikte olup, her açılı dönüşü uygun köşelerde kullanılır. 2 mm kalınlıkta olup, duvara yapıştımı ile uygulanır.
- Kolon ve duvar köşelerini koruma fonksiyonlarını yerine getirebilecek uygun bir boyda dikey olarak uygulanır.
- Köşe koruma profilleri, hastanelerde sedye ve tekerlekli sandalyelerin, havaalanları, otel ve alışveriş merkezlerinde de servis ve el arabalarının çarpmalarına karşı sütun ve duvar köşelerini korumak amacıyla kullanılır.
- Corner protection profiles used at the hospitals to protect walls and corners from litters and wheelchairs. Corner protection profile width 45x45 mm and proper for all angles.
- Has 2 mm thickness and used with glue to the wall.
- Appliance aimed to protect column and wall corners and used with proper height vertically.
- Corner protection profiles used for to protect corners and walls againts to litters and wheelchair where at the hospital, airport, hotel and shopping centers.

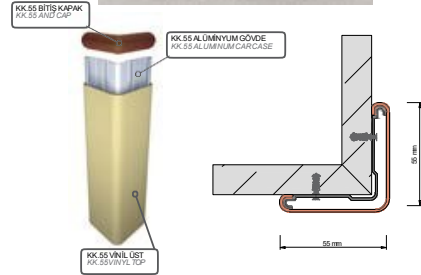
**KK.55**

- Köşe koruma profilleri 55x55 mm genişlikte 90 derecelik dönüşü uygundur.
- Kolon ve duvar köşelerini koruma fonksiyonlarını yerine getirebilecek uygun bir boyda dikey olarak uygulanır.
- Profil bitimlerinde bitim kapağı vardır.
- Doğrudan köşeye yapıştırılan veya alüminyum takviye profiline geçirilerek gizli vida ile tespit edilen iki tipi mevcuttur.
- Köşe koruma profilleri, hastanelerde sedye ve tekerlekli sandalyelerin, havaalanları, otel ve alışveriş merkezlerinde de servis ve el arabalarının çarpmalarına karşı sütun ve duvar köşelerini korumak amacıyla kullanılır.
- Corner protection profiles 55x55 mm wide and proper for 90 degree turn.
- Appliance aimed to protect column and wall corners and used with proper height vertically.
- There is a profile tap at the profile ending.
- There are two types which directly appose to the corner or attached with hidden screw to aluminium assistance profile.
- Corner protection profiles used for to protect corners and walls againts to litters and wheelchair where at the hospital, airport, hotel and shopping centers.

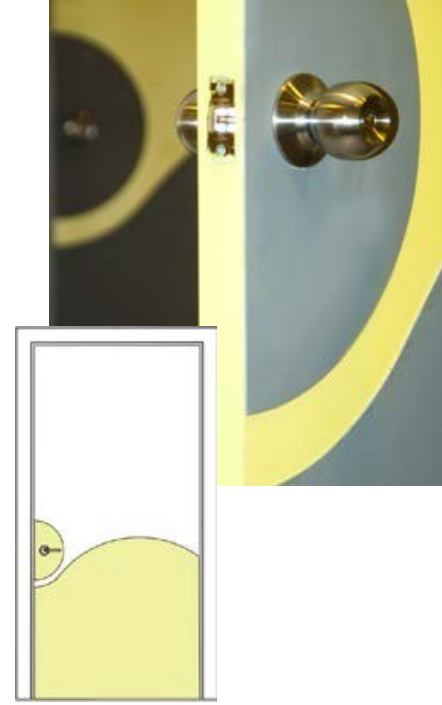
**KAPI PLAKA**

- 1,52 mm kalınlıkta ABS levhadan imal edilmiştir.
- Kapı tekmelerine ve sedye çarpmalarına uygun dekoratif şekil ve ölçülerdedir.
- Antibakteriyeldir. Herhangi bir kimyasal ve zehirli gaz içermeyip koku yapmaz.
- Darbe dayanımına sahip, aşınma ve çizilmeye karşı dirençlidir.
- Sıcak ve nemden etkilenmemektedir.
- Yanmaya karşı geçiktirici alev yürümez özelliktedir.
- It is manufactured from ABS Plate and has thickness 1,52 mm.
- It has a adjustable size and decoration which is suitable for door kicks and litter dash.
- It is antibacterial. It has not emitted any chemical or gas with poison or savour.
- It is durable for bump and resistible for scratch and dust
- It is resistible against heat and humidity.
- It has not reactivity against the circum-stance of fire (fire not driven).

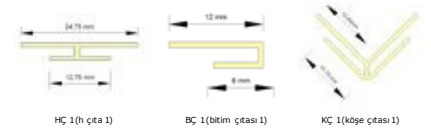
**VİNİL PLAKA**

- 1,52 mm kalınlıkta ABS levhadan imal edilmiştir.
- Plaka boyları 3000-1000 mm veya 3000-1300 mm ölçülerindedir. Antibakteriyeldir. Herhangi bir kimyasal ve zehirli gaz içermeyip koku yapmaz.
- Darbe dayanımına sahip, aşınma ve çizilmeye karşı dirençlidir.
- Sıcak ve nemden etkilenmemektedir.
- Yanmaya karşı geçiktirici alev yürümez özelliktedir.
- Duvara uygun yapıştırıcı ile monte edilir.
- It is manufactured from ABS Plate and has thickness. 1,52 mm mount with proper glue to the wall.
- It Plate heights 3000-1000 mm or 3000-1300 mm sizes.
- It is antibacterial. It has not emitted any chemical or gas with poison or savour.
- It is durable for bump and resistible for scratch and dust.
- It is resistible against heat and humidity.
- It has not reactivity against the circum-stance of fire (fire not driven).

CG-50 B

DUVAR KORUMA BANTLARI
WALL PROTECTION BAND

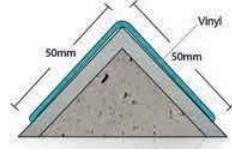

CG-76

DUVAR KORUMA BANTLARI
WALL PROTECTION BAND

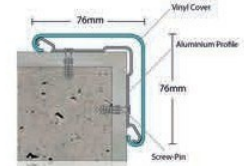

CG-50

DUVAR KORUMA BANTLARI
WALL PROTECTION BAND

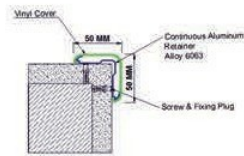
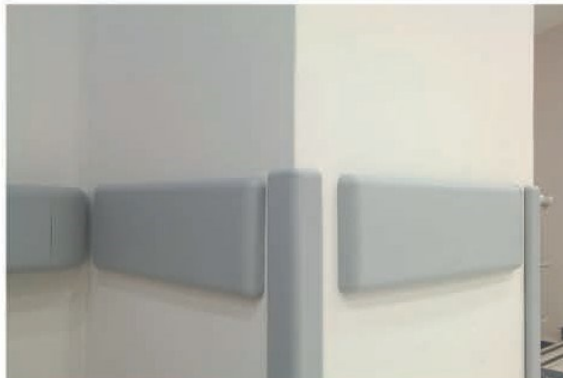

DC-150

DUVAR KORUMA BANTLARI
WALL PROTECTION BAND

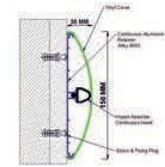

DC-200

DUVAR KORUMA BANTLARI
WALL PROTECTION BAND

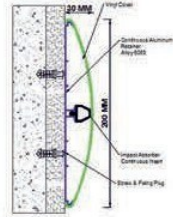

WG-42-2

DUVAR KORUMA BANTLARI
WALL PROTECTION BAND

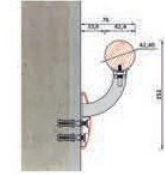

WG-42-1

DUVAR KORUMA BANTLARI
WALL PROTECTION BAND

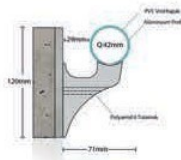

WG-42-3

DUVAR KORUMA BANTLARI
WALL PROTECTION BAND

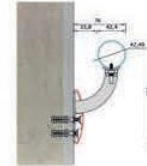

WG-42-4

DUVAR KORUMA BANTLARI
WALL PROTECTION BAND

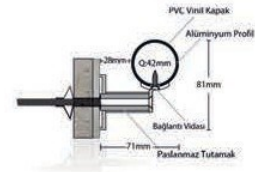

WG-146

DUVAR KORUMA BANTLARI
WALL PROTECTION BAND

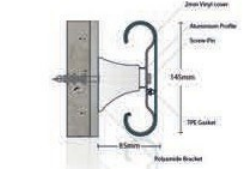

WG-50

DUVAR KORUMA BANTLARI
WALL PROTECTION BAND

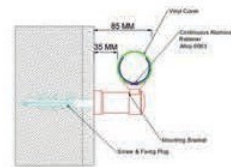

WG-145

DUVAR KORUMA BANTLARI
WALL PROTECTION BAND

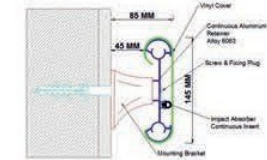

WG-152-1

DUVAR KORUMA BANTLARI
WALL PROTECTION BAND

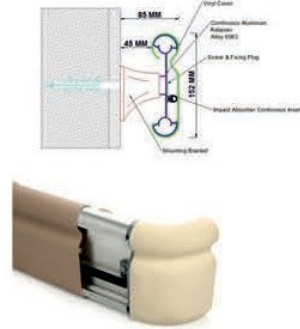

WG-200

DUVAR KORUMA BANTLARI
WALL PROTECTION BAND

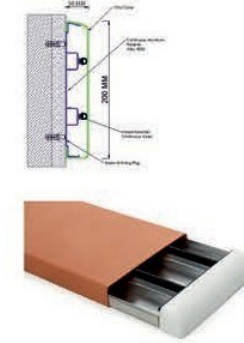

WG-152-2

DUVAR KORUMA BANTLARI
WALL PROTECTION BAND

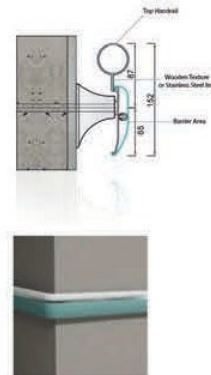

WG-201

DUVAR KORUMA BANTLARI
WALL PROTECTION BAND

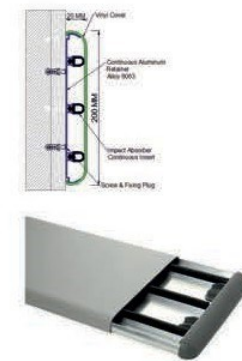

CR-50

DUVAR KORUMA BANTLARI
WALL PROTECTION BAND

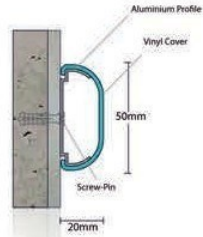

RG-100

DUVAR KORUMA BANTLARI
WALL PROTECTION BAND

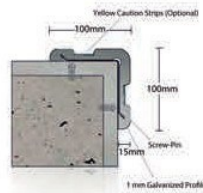

DUVAR KORUMA BANTLARI
WALL PROTECTION BAND

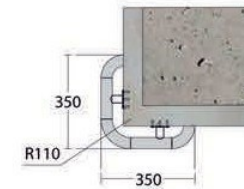
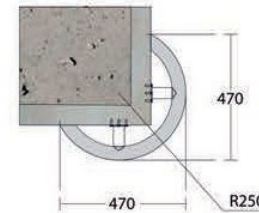

WG-200 SS

DUVAR KORUMA BANTLARI
WALL PROTECTION BAND

